

MT444-3CFWD

PERFECT GRIND®

CONTINUOUS FEED 1/2 HP
FOOD WASTE DISPOSER

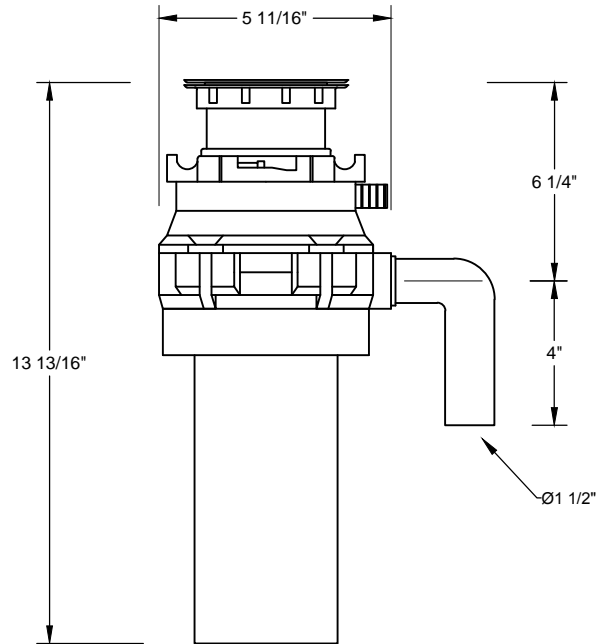

This model offers the following features:

- Permanent Magnet High RPM Means High Torque and Less Jams
- Bio-guard Antimicrobial Protection
- Removable Splash Guard
- Factory Installed Power Cord with Plug
- Safe for Properly Sized Septic Tanks
- E-Z Connect No Tool Mounting System

WARRANTY

THE 1/2 HP MOUNTAIN PERFECT GRIND WASTE DISPOSER COMES WITH A 3 YEAR LIMITED REPLACEMENT WARRANTY.



SPECIFICATIONS

HP	1/2
Motor Type	Permanent Magnet
Feed	Continuous
Volts	110V
Frequency	50/60Hz
Motor Speed	2500RPM
Hopper Capacity	29oz
Balance Level	G0.4
Sink Flange	Stainless Steel
Stopper	Stainless Steel
Drain Elbow	ABS
Bearings	Permanently Lubricated, Sleeve Type
Manual Reset Protector	Protection for Overload and Temp.
Shipping Weight	9.7lbs
Pallet Quantity	144pcs