

MT6931-NL SPECIFICATIONS

LAVATORY SUPPLY KIT



SUPPLY TUBES &
VALVES

THIS DECORATIVE P TRAP KIT OFFERS THE FOLLOWING FEATURES:

- TWO MT6004-NL VALVES WITH 1/4 TURN CERAMIC DISC CARTRIDGE AND ESCUTCHEON
- TWO MT432X NO LEAD SUPPLY TUBES
- OFFERED IN MANY STANDARD DECORATIVE FINISHES
- SPECIAL FINISHES AVAILABLE UPON REQUEST

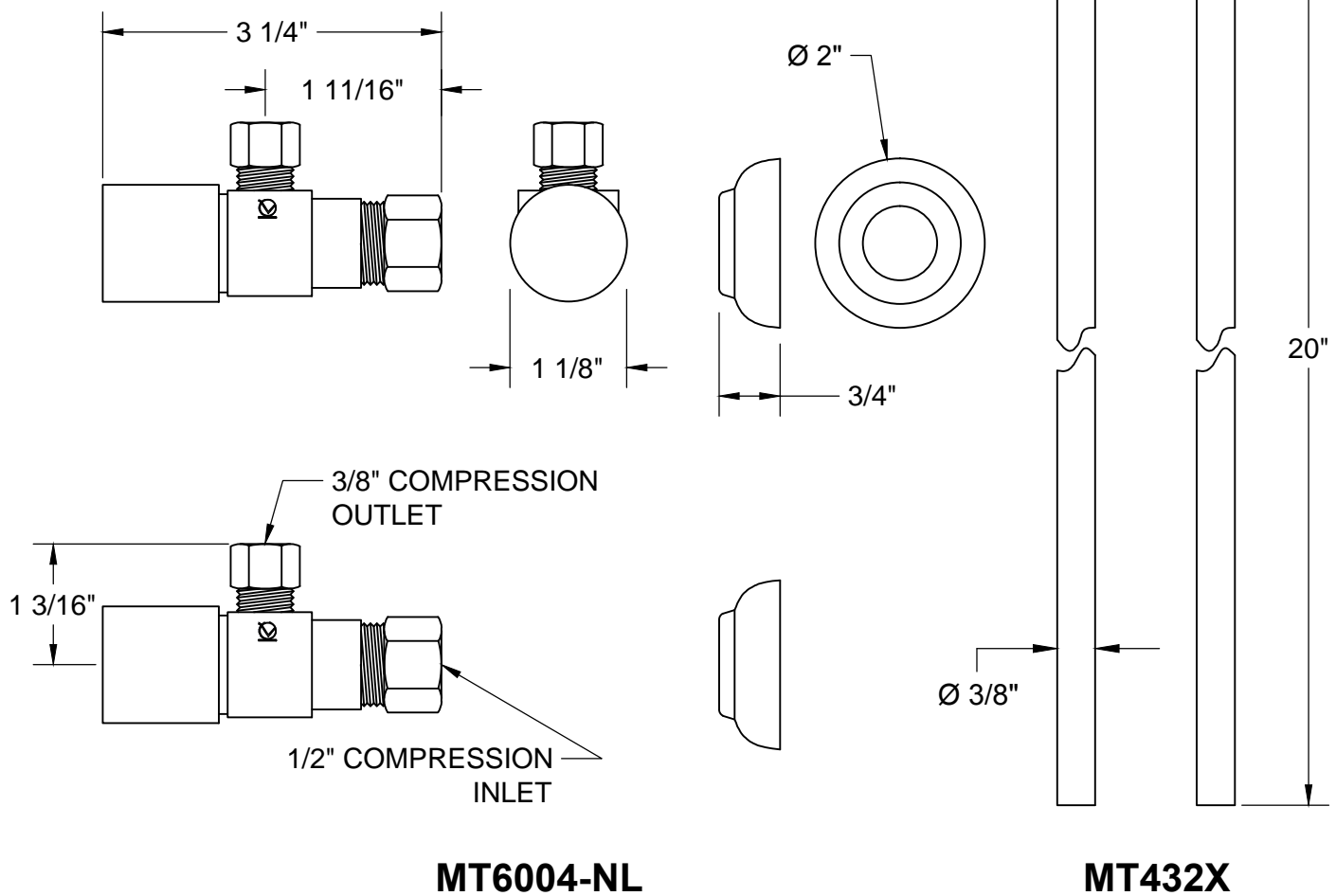

WARRANTY

ONE YEAR WARRANTY ON PLATED FINISHES, 90 DAY WARRANTY ON ORB, EB, MHB, TB AND WCP AND LIFETIME ON PVD PROVIDED PROPER CARE HAS BEEN USED. ONE YEAR WARRANTY ON ALL PARTS. APPLIES TO ORIGINAL PURCHASER. CLAIMS REQUIRE PROOF OF PURCHASE.

FINISH CARE & MAINTENANCE

NEVER USE ANY HARSH ALKALI, ACID BASED DETERGENTS OR CLEANERS SUCH AS SOFT SCRUB®, SCRUBBING BUBBLES® OR COMET® TO CLEAN. DO NOT USE BRILLO® AND SCOTCH BRITE® PADS. THESE WILL ALL HARM THE FINISH. TO CLEAN, USE ONLY A DAMP SOFT CLOTH AND WIPE USING A SOFT CLOTH. STANDARD WINDEX CAN ALSO BE USED SPARINGLY. TO MAINTAIN THE FINISH, WIPE WITH A SOFT DRY CLOTH. AN OCCASIONAL COAT OF PURE CARNUBA WAX WITHOUT CLEANERS WILL HELP PROTECT THE FINISH.